

Notes:

1. SYSTEM WEIGHT: 2,964 LBS. (INCLUDES FUTURE EXPANSION PUMP)
2. ☒ INDICATES LIFTING POINT.
3. ● DENOTES CENTER OF GRAVITY. (INCLUDES FUTURE EXPANSION PUMP)

SYSTEM CONNECTIONS	
ID	DESCRIPTION
I	INLET LOCATION
D	DISCHARGE LOCATION
C	CONDENSATE DRAIN LOCATION
T	TANK DRAIN LOCATION

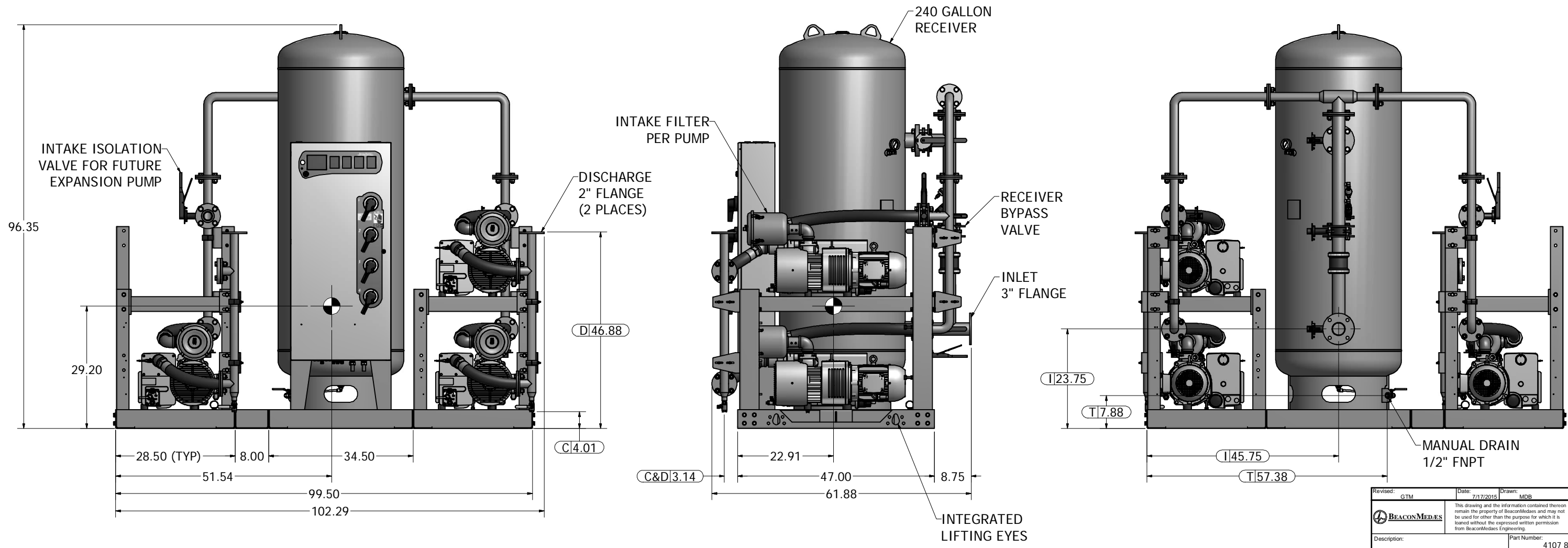

Revised: GTM	Date: 7/17/2015	Drawn: MDB	Date: 11/8/2010
		This drawing and the information contained therein remain the property of BeaconMedes and may not be used for other than the purpose for which it is loaned without the expressed written permission from BeaconMedes Engineering.	
Description: GENERAL ASSEMBLY 5HP TX-X-QX LUBE VAC SPC 240G RECEIVER		Part Number: 4107 8522 94	Scale: 1/12
Sheet 1 of 1		Rev: 01	DO NOT SCALE THIS DOCUMENT