

Notes:

1. SYSTEM WEIGHT: 6,922 LBS.
(INCLUDES FUTURE EXPANSION PUMP)
2. ☒ INDICATES LIFTING POINT.
3. ● DENOTES CENTER OF GRAVITY.
(INCLUDES FUTURE EXPANSION PUMP)

SYSTEM CONNECTIONS	
ID	DESCRIPTION
I	INLET LOCATION
D	DISCHARGE LOCATION
C	CONDENSATE DRAIN LOCATION
T	TANK DRAIN LOCATION

MINIMUM CLEARANCE FOR MAINTENANCE & VENTILATION

INTAKE ISOLATION VALVE FOR FUTURE EXPANSION PUMP

FUTURE EXPANSION PUMP

ELECTRICAL CONNECTION

Ø0.75 BOLTSDOWNS (8 PLACES)

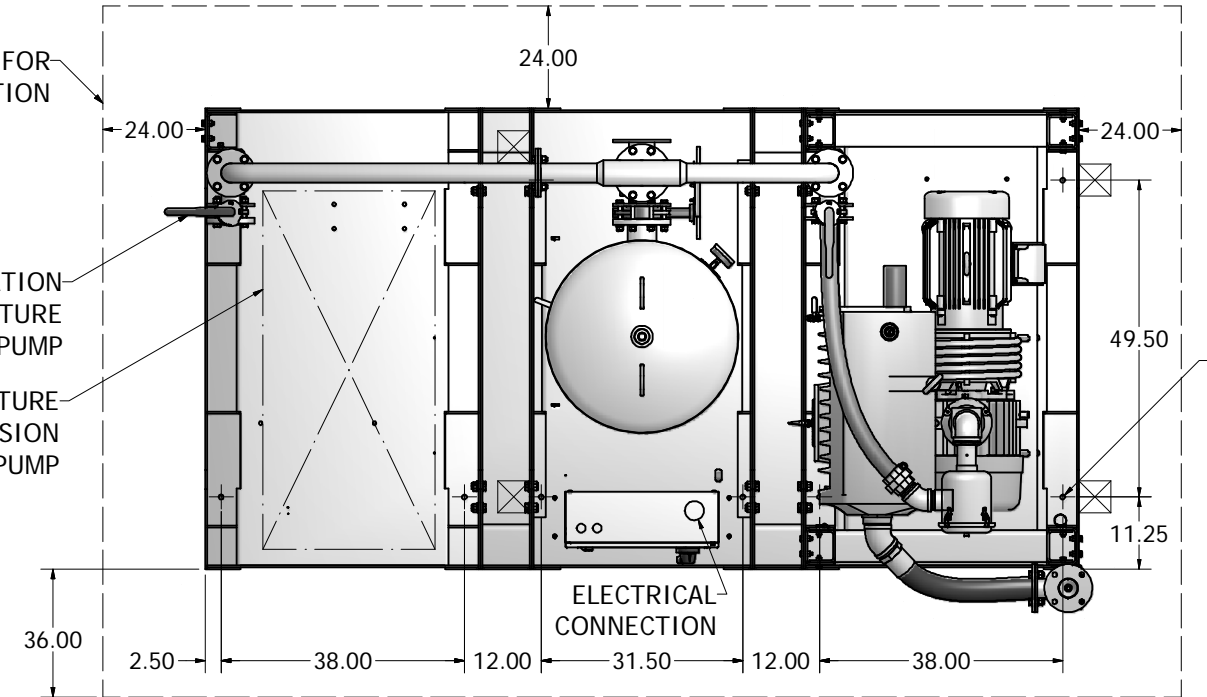

240 GALLON RECEIVER

INTAKE FILTER PER PUMP

DISCHARGE 3" FLANGE

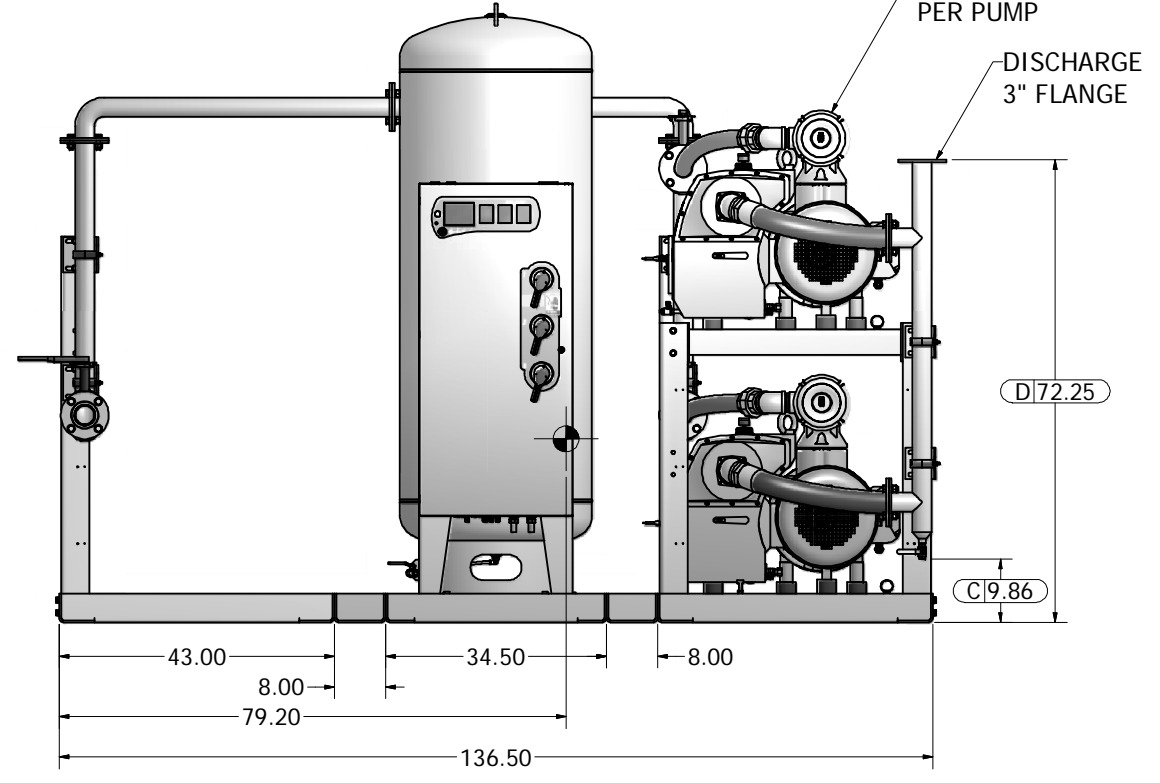
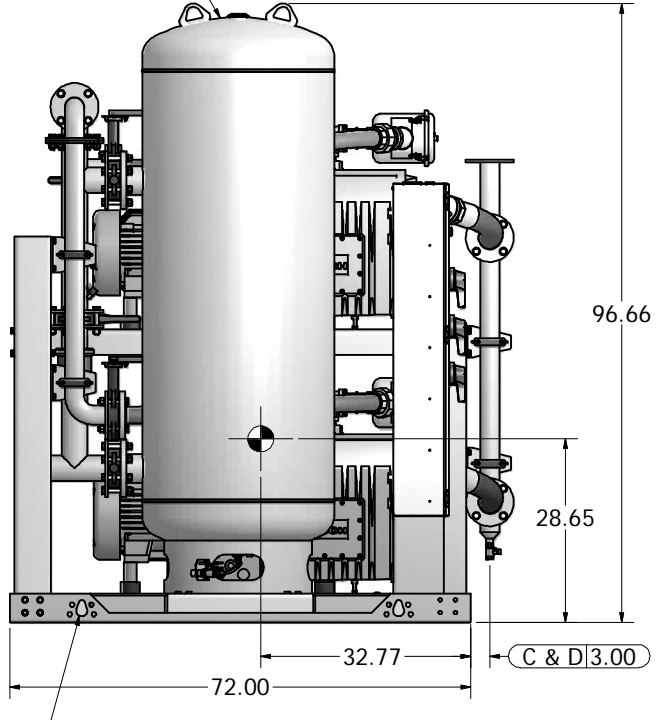
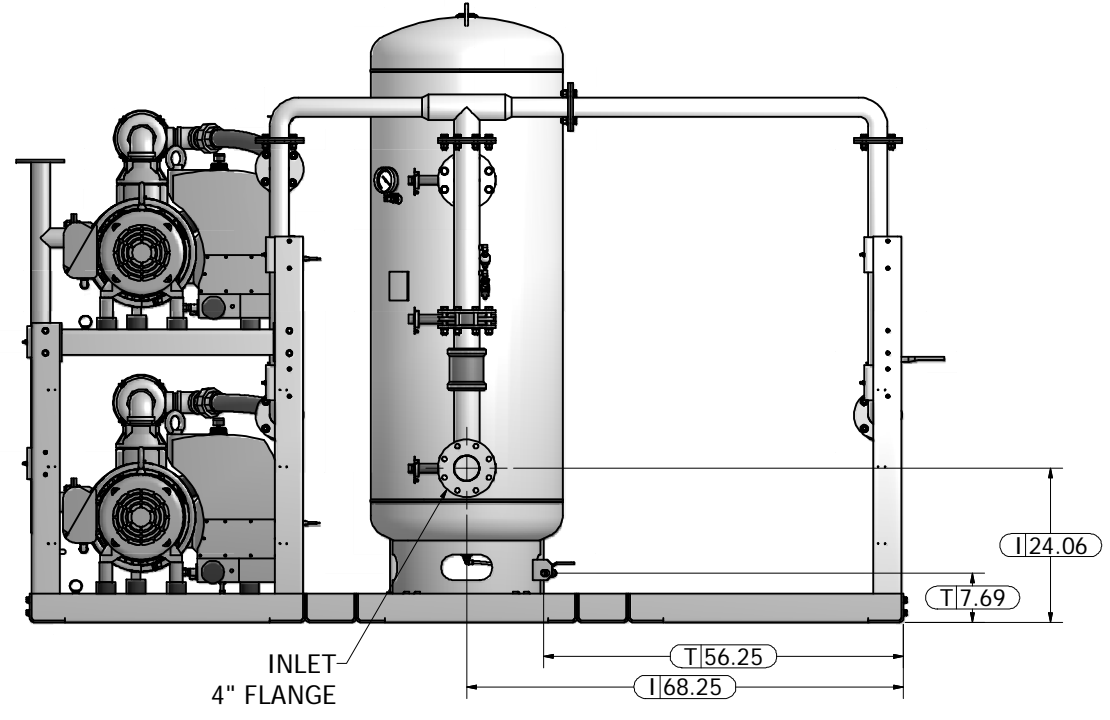

INTEGRATED LIFTING EYES

Revised:	Date:	Drawn:	Date:
		MDB	10/4/2010
		This drawing and the information contained therein remain the property of BeaconMedes and may not be used for other than the purpose for which it is loaned without the expressed written permission from BeaconMedes Engineering.	
Description: GENERAL ASSEMBLY 15HP DX-EXP-TX LUBE VAC SPC 240G RECEIVER		Part Number: 4107 8522 88 DN: HOP100688 Rev: 00 Sheet 1 of 1	
		Scale: 1/15 D DO NOT SCALE THIS DOCUMENT	