





Notes:

1. SYSTEM WEIGHT: 7,432 LBS.
2.  INDICATES LIFTING POINT.
3.  DENOTES CENTER OF GRAVITY.

SYSTEM CONNECTIONS	
ID	DESCRIPTION
I	INLET LOCATION
D	DISCHARGE LOCATION
C	CONDENSATE DRAIN LOCATION
T	TANK DRAIN LOCATION

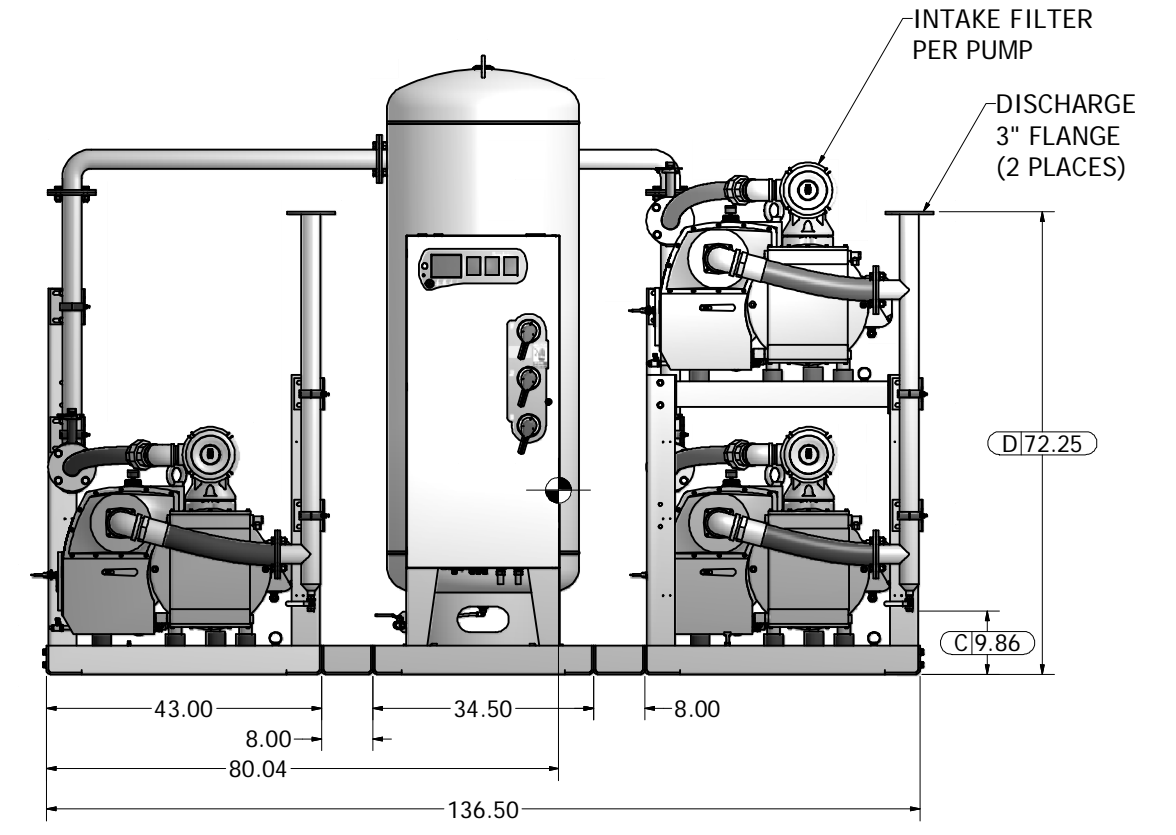
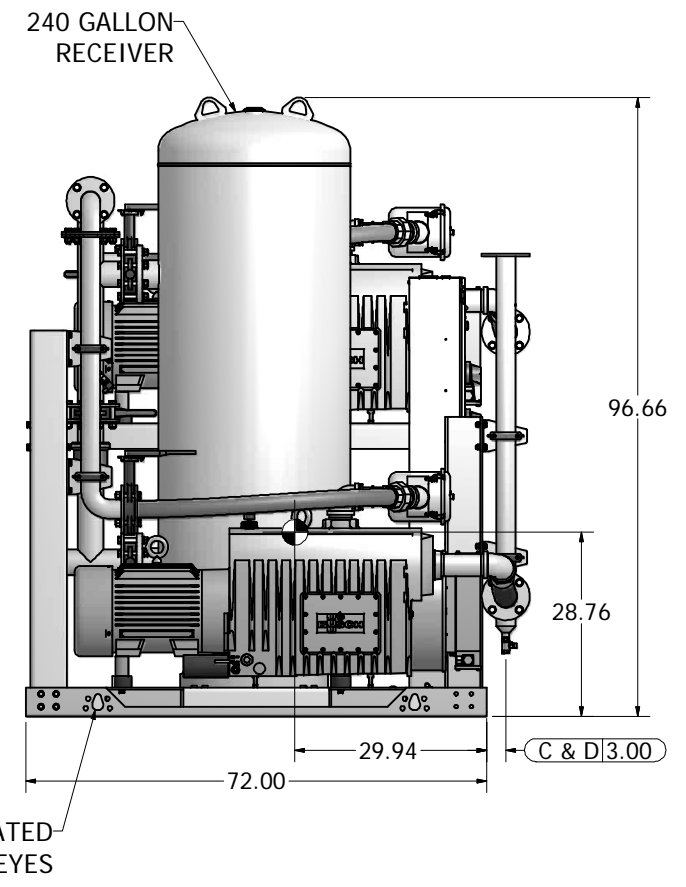
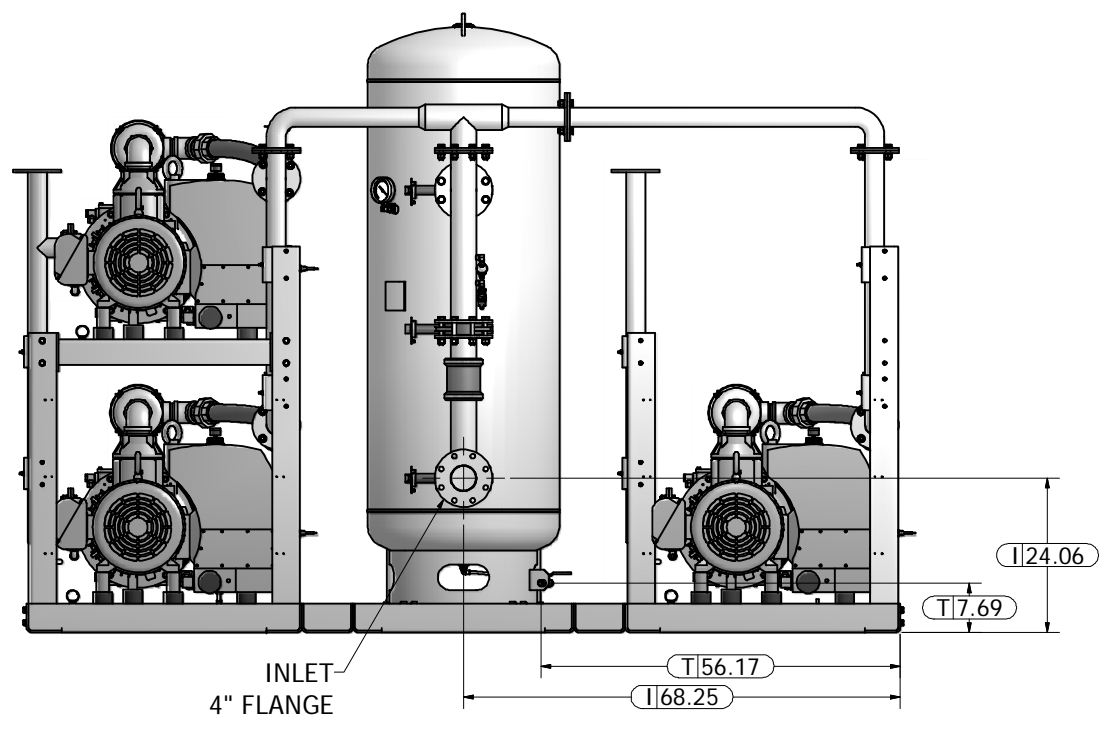
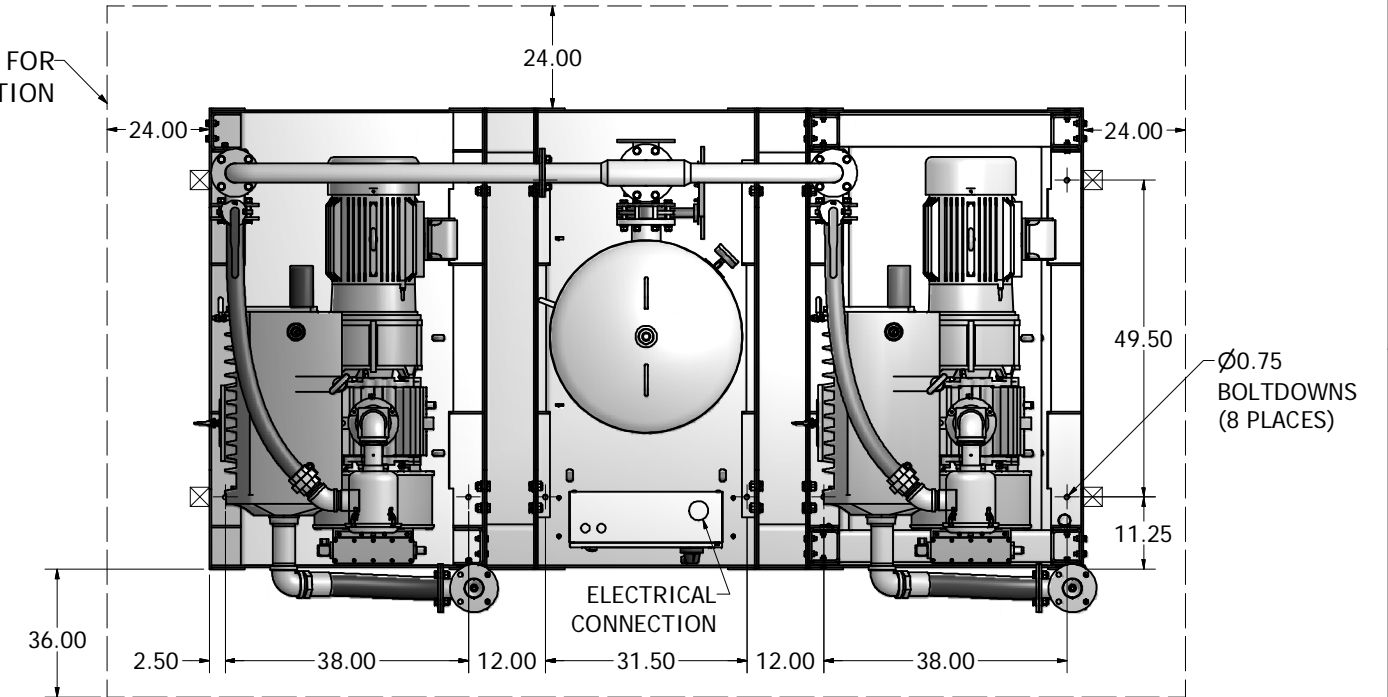
MINIMUM CLEARANCE FOR MAINTENANCE & VENTILATION



Revised:	Date:	Drawn: MDB	Date: 10/4/2010
		This drawing and the information contained therein remain the property of BeaconMedes and may not be used for other than the purpose for which it is loaned without the expressed written permission from BeaconMedes Engineering.	
Description:		Part Number: 4107 8522 52	
GENERAL ASSEMBLY 20HP TX LUBE VAC SPC 240G RECEIVER		DN: HOP100497	Rev: 00
Sheet 1 of 1		DO NOT SCALE THIS DOCUMENT	