





Notes:

1. SYSTEM WEIGHT: 7,357 LBS.
2.  INDICATES LIFTING POINT.
3.  DENOTES CENTER OF GRAVITY.

SYSTEM CONNECTIONS	
ID	DESCRIPTION
I	INLET LOCATION
D	DISCHARGE LOCATION
C	CONDENSATE DRAIN LOCATION
T	TANK DRAIN LOCATION

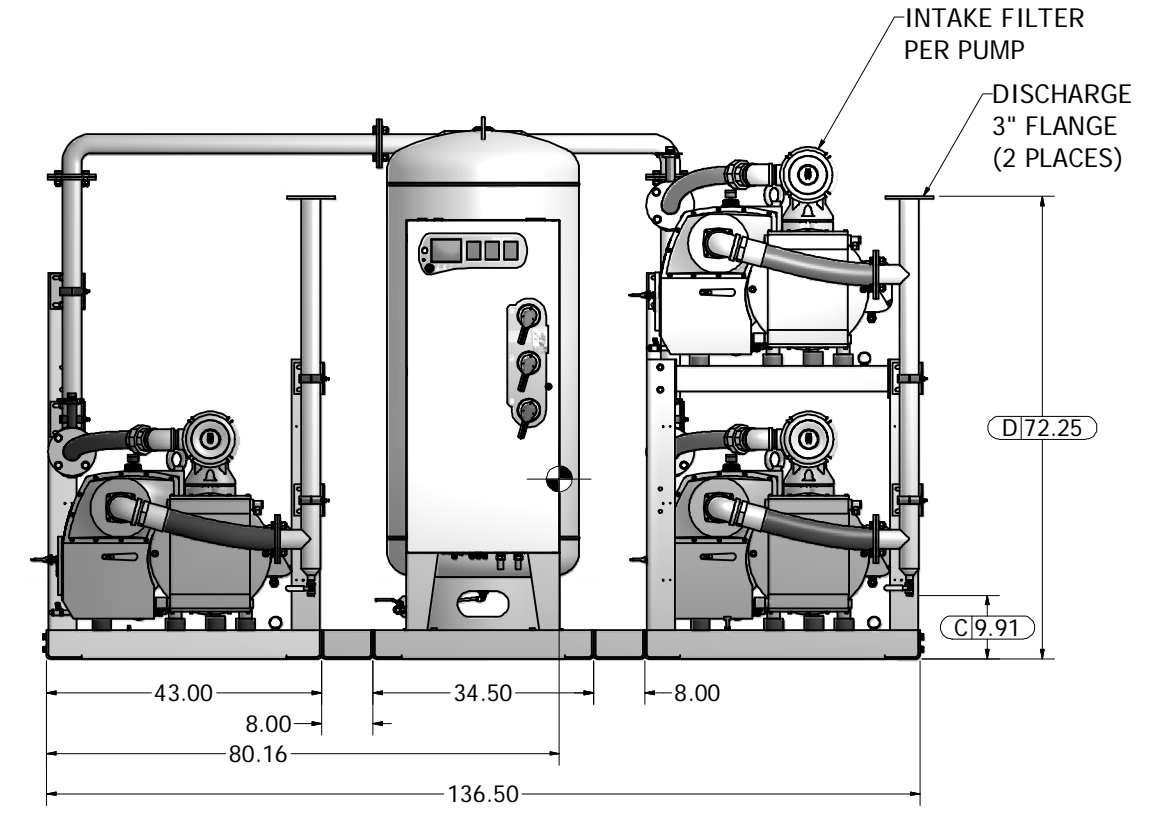
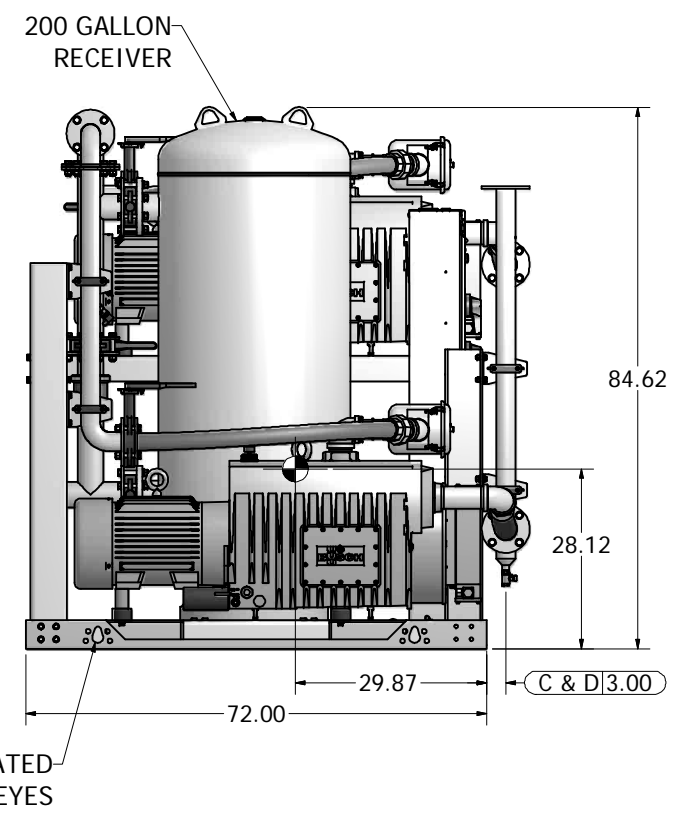
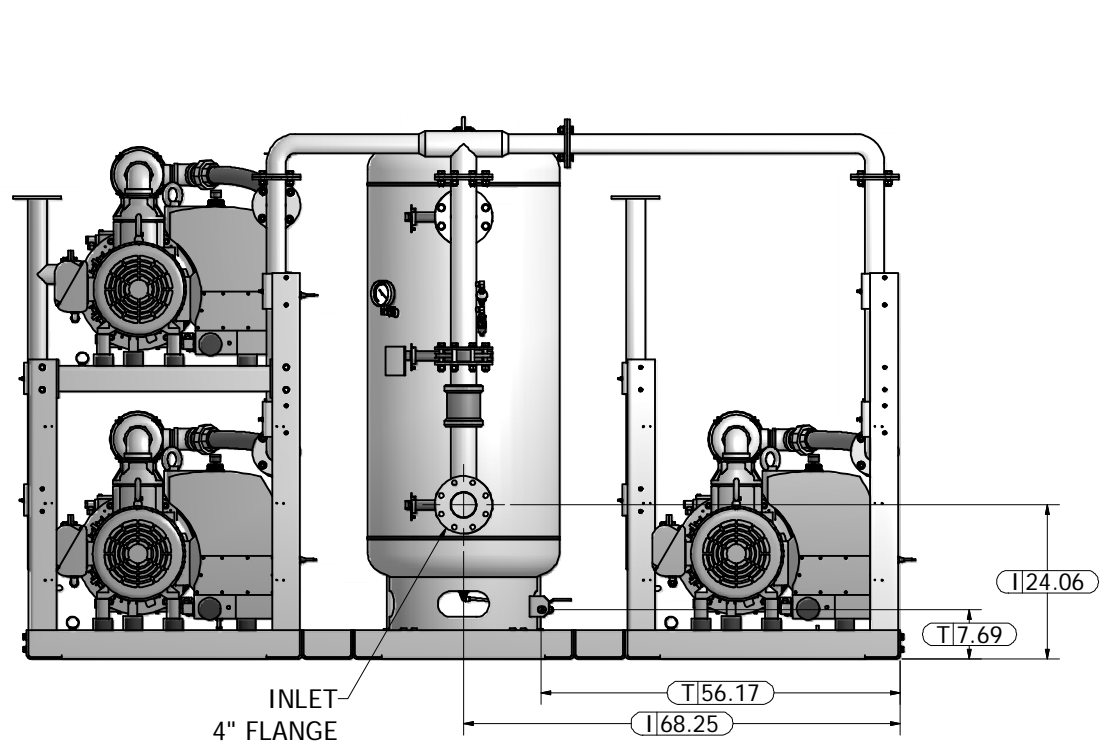
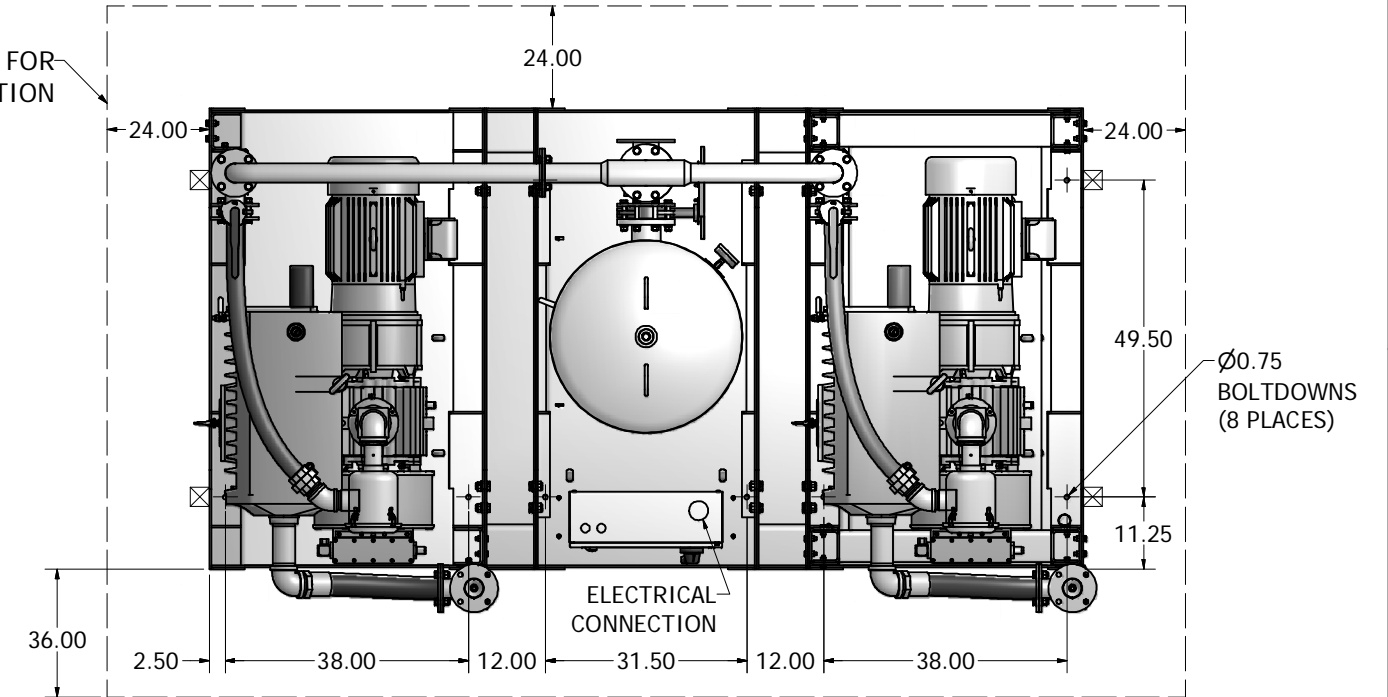
MINIMUM CLEARANCE FOR MAINTENANCE & VENTILATION



Revised:	Date:	Drawn:	Date:
		MDB	10/4/2010
		This drawing and the information contained therein remain the property of BeaconMedes and may not be used for other than the purpose for which it is loaned without the expressed written permission from BeaconMedes Engineering.	
Description:		Part Number:	
GENERAL ASSEMBLY 20HP TX LUBE VAC SPC 200G RECEIVER		4107 8522 51	
DN:	Rev:	Scale:	
HOP100497	00	1/15	
Sheet	1 of 1	DO NOT SCALE THIS DOCUMENT	