

Notes:

1. DISCHARGE MUFFLERS WILL BE SHIPPED LOOSE.
2. SYSTEM WEIGHT: 4,461 LBS.
3. ☒ INDICATES LIFTING POINT.
4. ● DENOTES CENTER OF GRAVITY.

SYSTEM CONNECTIONS	
ID	DESCRIPTION
I	INLET LOCATION
D	DISCHARGE LOCATION
C	CONDENSATE DRAIN LOCATION
T	TANK DRAIN LOCATION

MINIMUM CLEARANCE FOR MAINTENANCE & VENTILATION

Ø0.75 BOLTDOWNS (12 PLACES)

ELECTRICAL CONNECTION

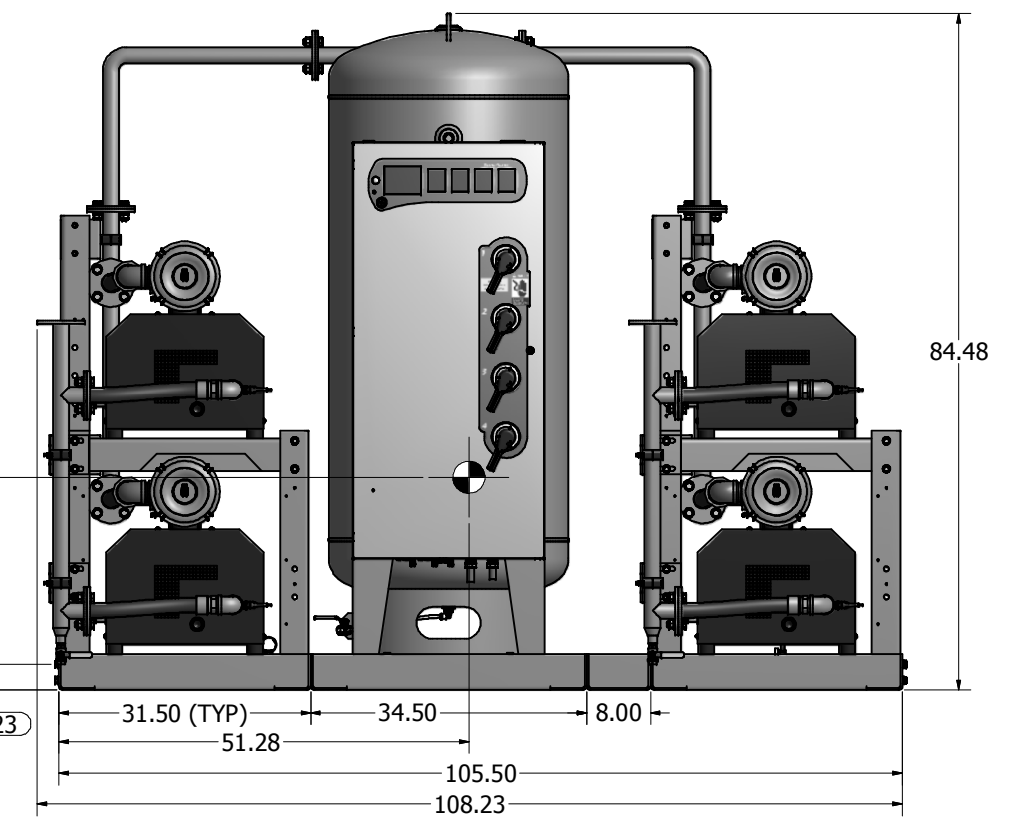
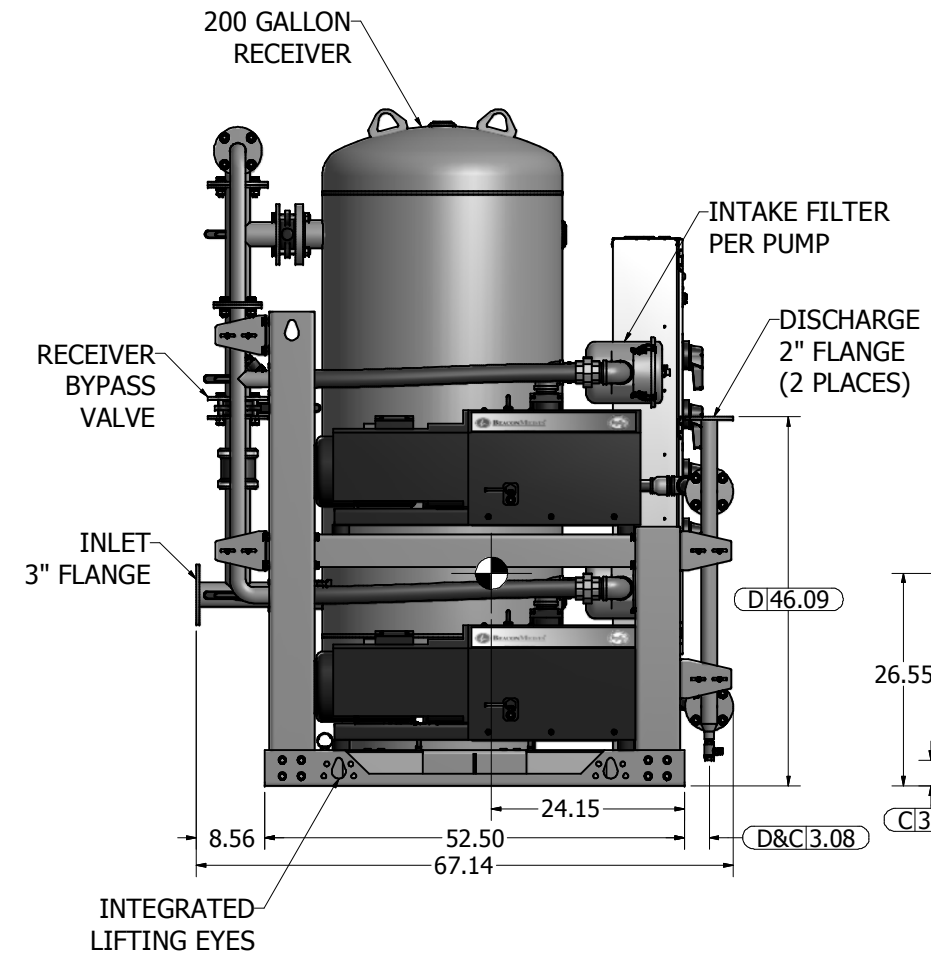
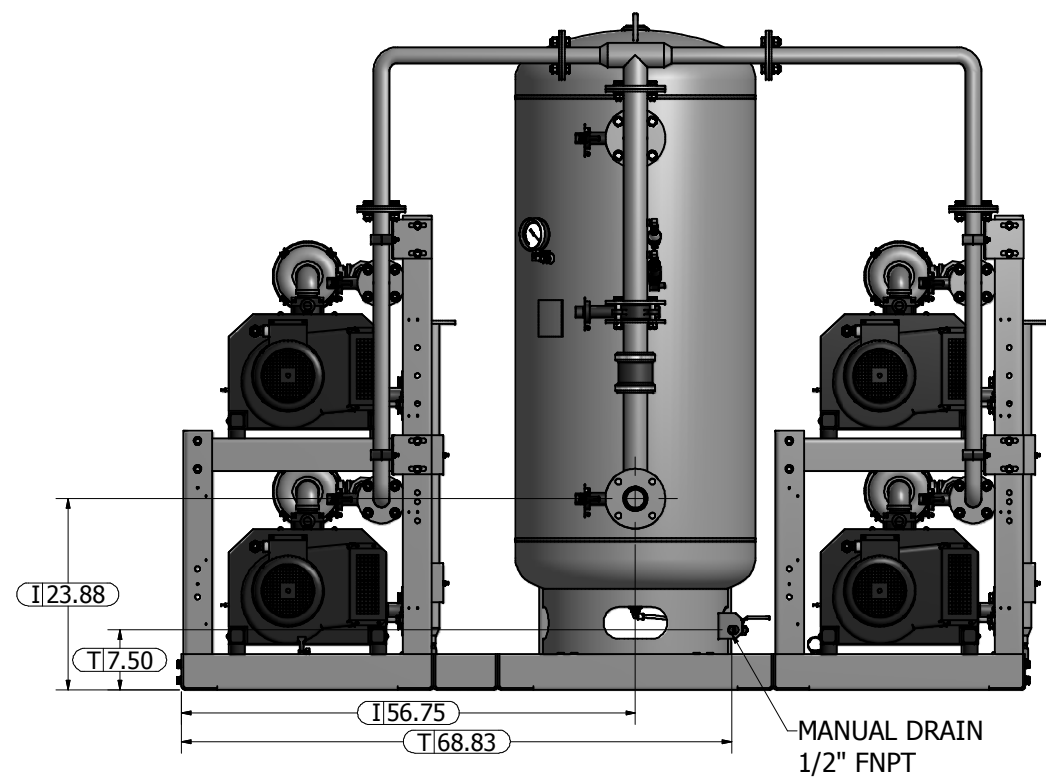
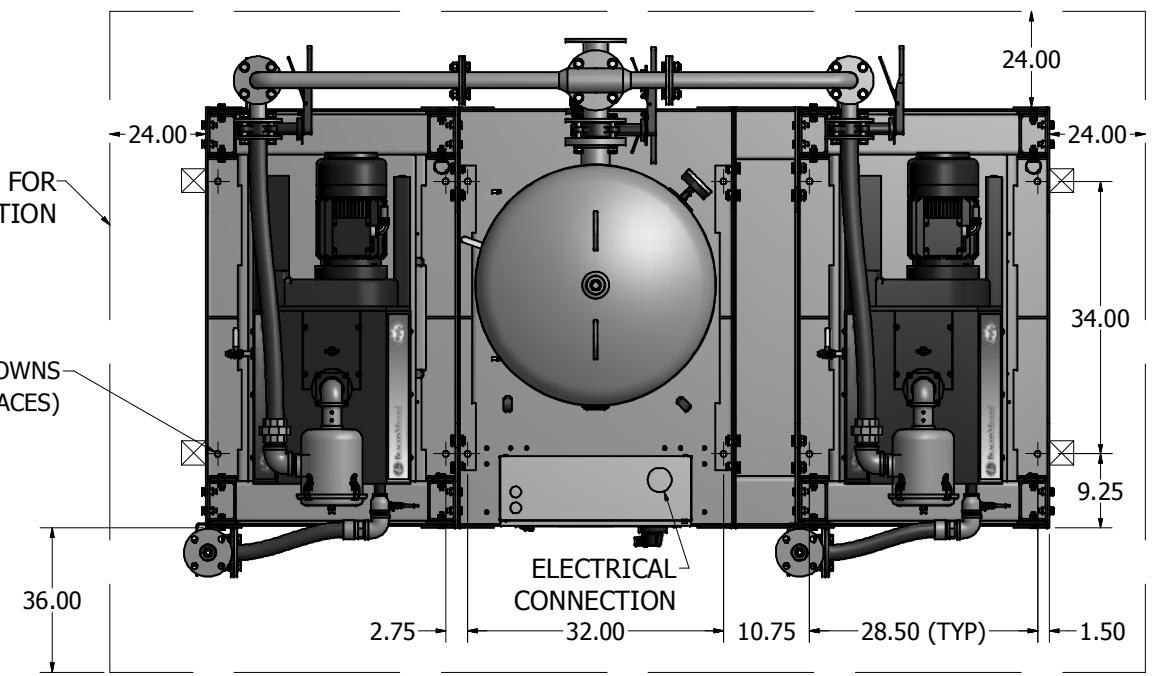

Revised:	Date:	Drawn: MDB	Date: 2/4/2010
		This drawing and the information contained therein remain the property of BeaconMedes and may not be used for other than the purpose for which it is loaned without the expressed written permission from BeaconMedes Engineering.	
Description: GENERAL ASSEMBLY 7.5HP QX CLAW VAC SPC 200G RECEIVER STANDARD & O2 ASSURED		Part Number: 4107 8513 84	
DN: USN090195		Rev: 00	
Sheet 1 of 1		DO NOT SCALE THIS DOCUMENT	