

Notes:

- DISCHARGE MUFFLERS WILL BE SHIPPED LOOSE.
- SYSTEM WEIGHT: 4,520 LBS.
- ☒ INDICATES LIFTING POINT.
- DENOTES CENTER OF GRAVITY.

SYSTEM CONNECTIONS	
ID	DESCRIPTION
I	INLET LOCATION
D	DISCHARGE LOCATION
C	CONDENSATE DRAIN LOCATION
T	TANK DRAIN LOCATION

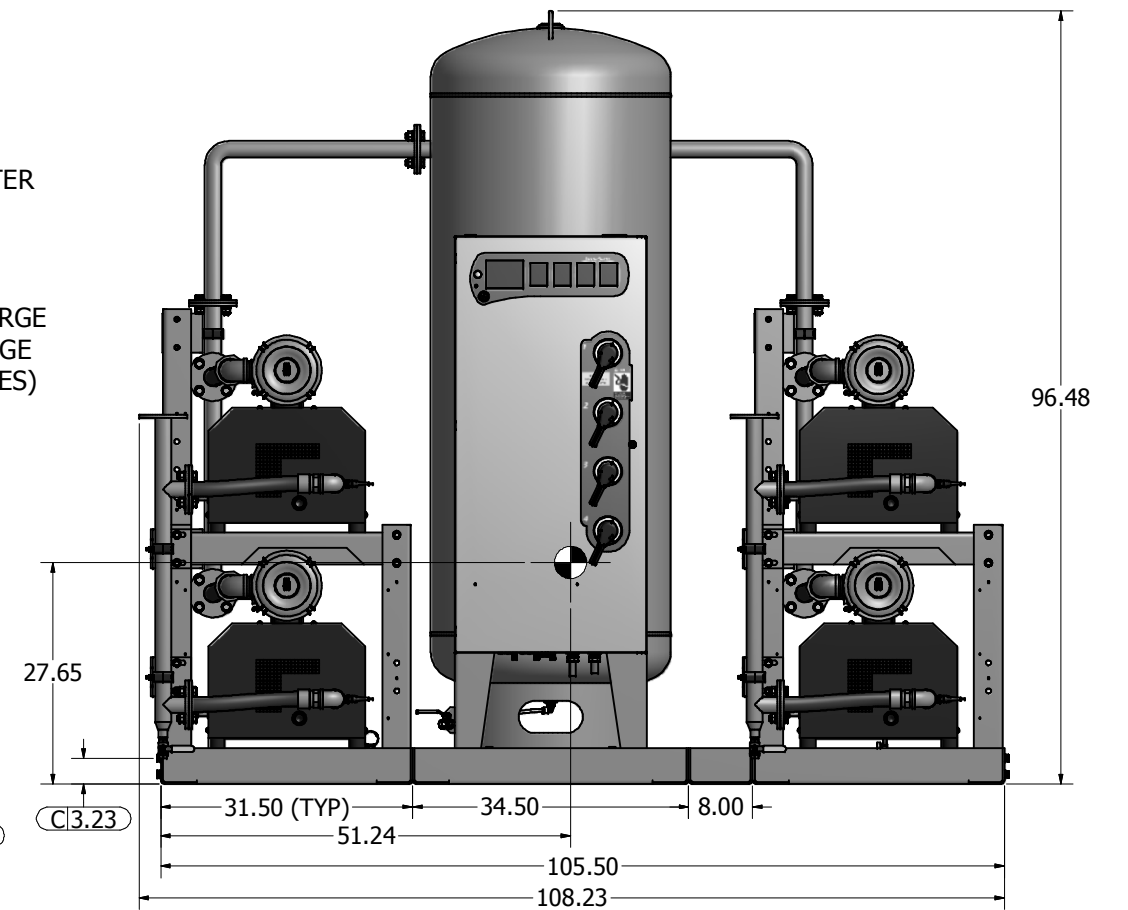
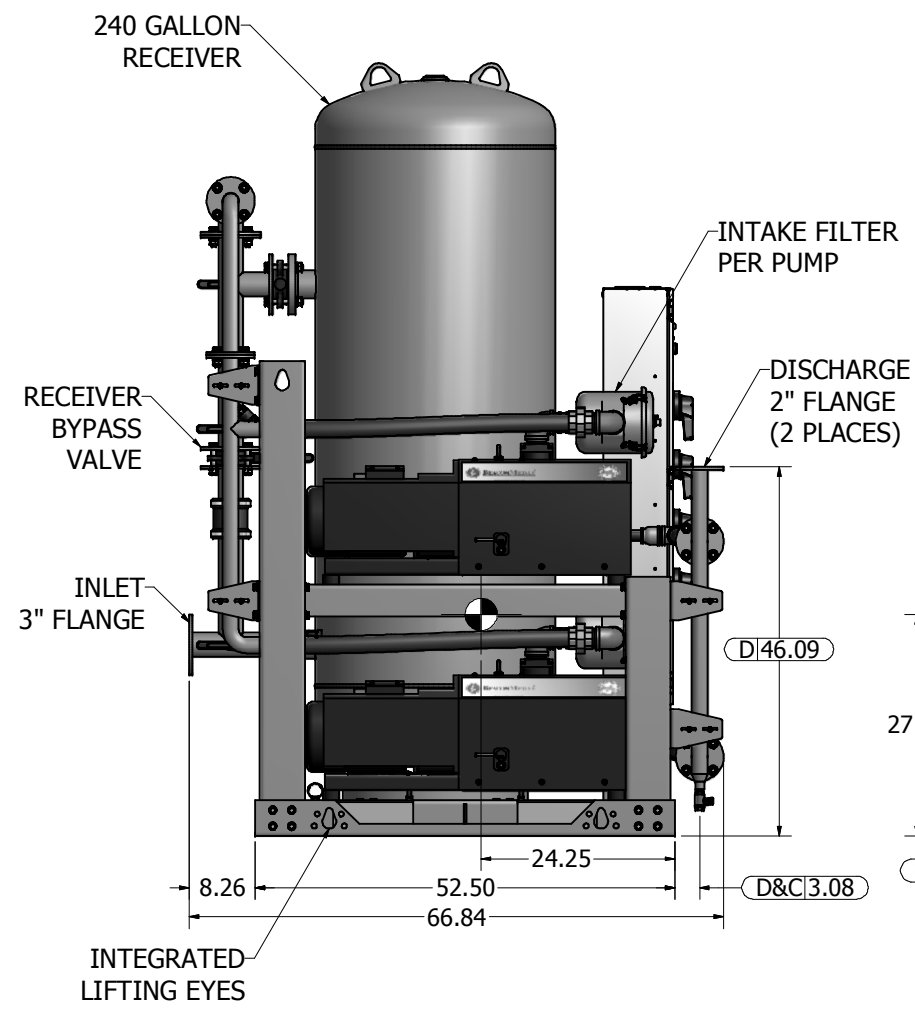
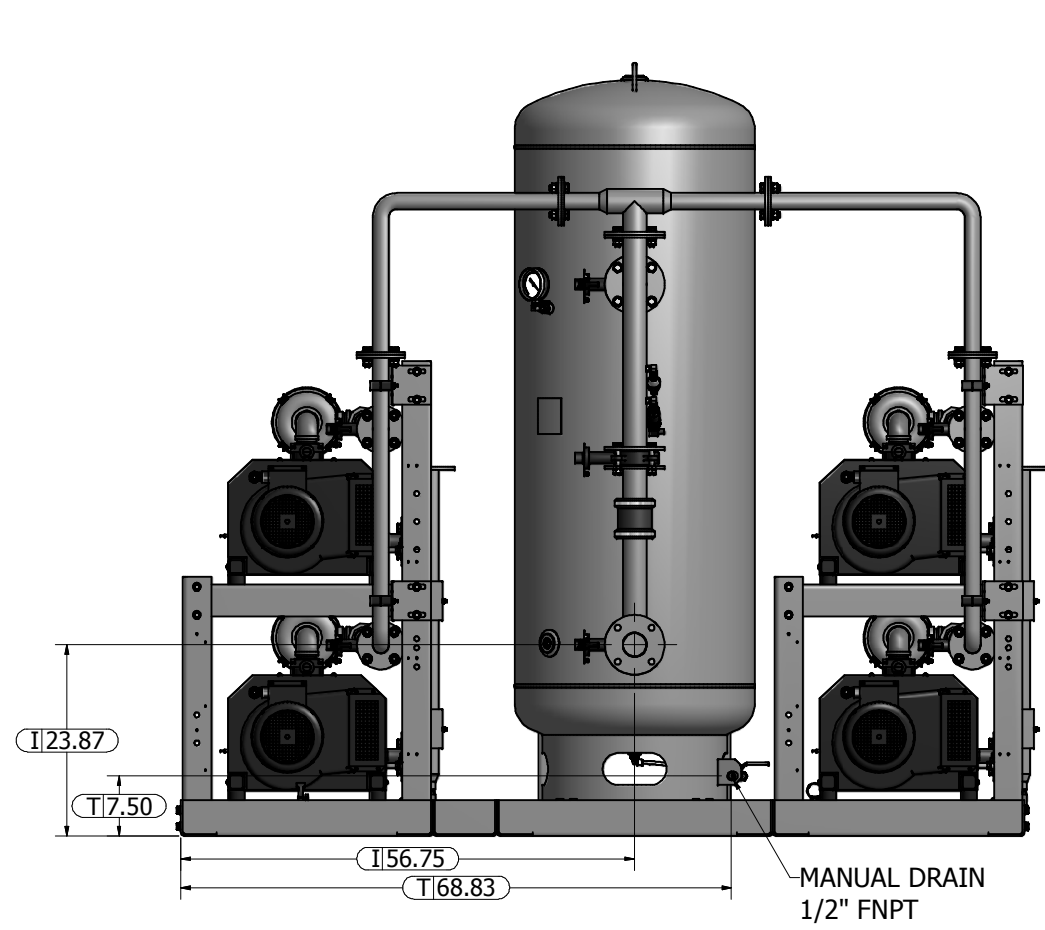
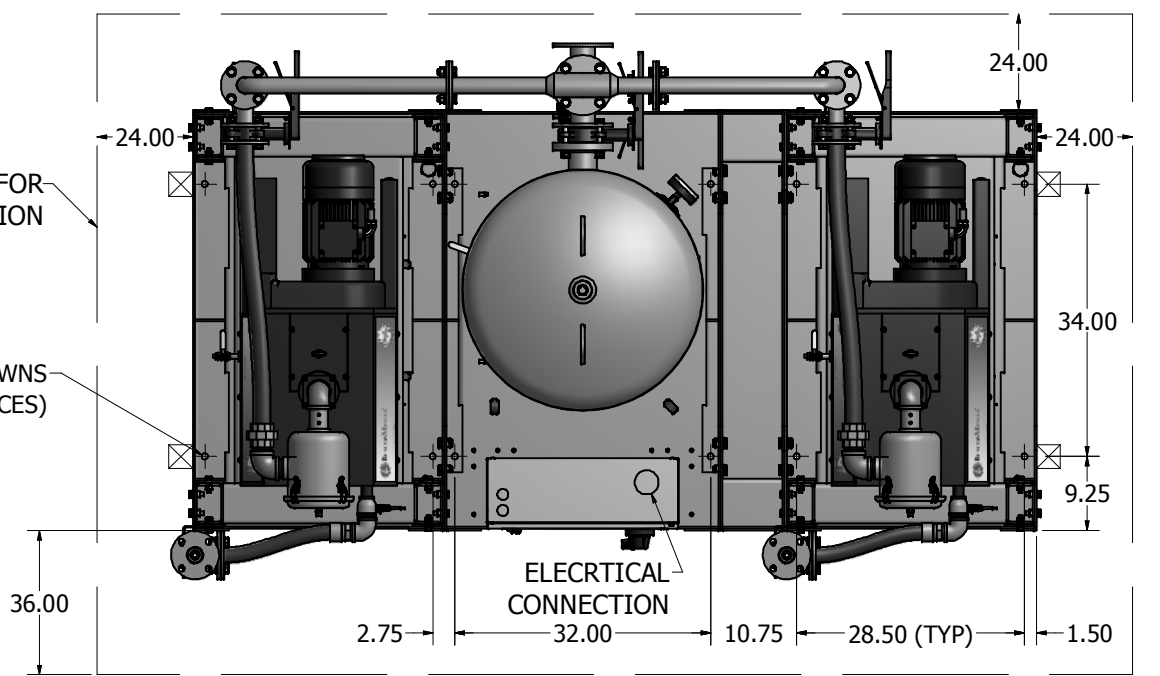

Revised:	Date:	Drawn: MDB	Date: 2/4/2010
		This drawing and the information contained therein remain the property of BeaconMedes and may not be used for other than the purpose for which it is loaned without the expressed written permission from BeaconMedes Engineering.	
Description: GENERAL ASSEMBLY 6.4HP QX CLAW VAC SPC 240G RECEIVER STANDARD & O2 ASSURED		Part Number: 4107 8513 83	
DN: USN090195		Rev: 00	
Sheet 1 of 1		DO NOT SCALE THIS DOCUMENT	