





Notes:

1. DISCHARGE MUFFLER WILL BE SHIPPED LOOSE.
2. SYSTEM WEIGHT: 3,487 LBS.
3.  INDICATES LIFTING POINT.
4.  DENOTES CENTER OF GRAVITY.

SYSTEM CONNECTIONS	
ID	DESCRIPTION
I	INLET LOCATION
D	DISCHARGE LOCATION
C	CONDENSATE DRAIN LOCATION
T	TANK DRAIN LOCATION

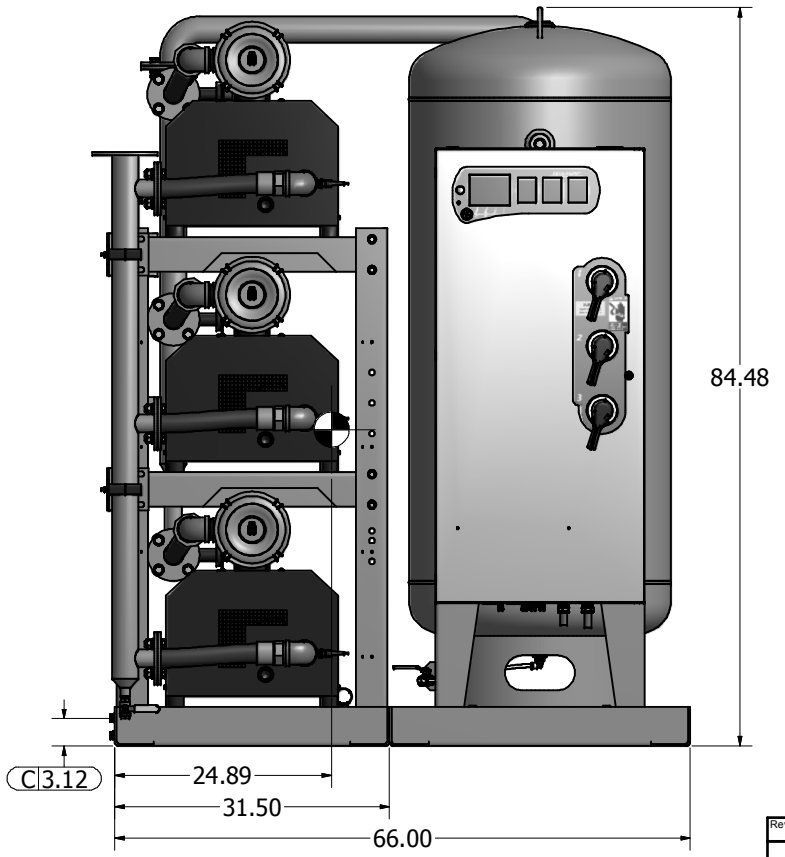
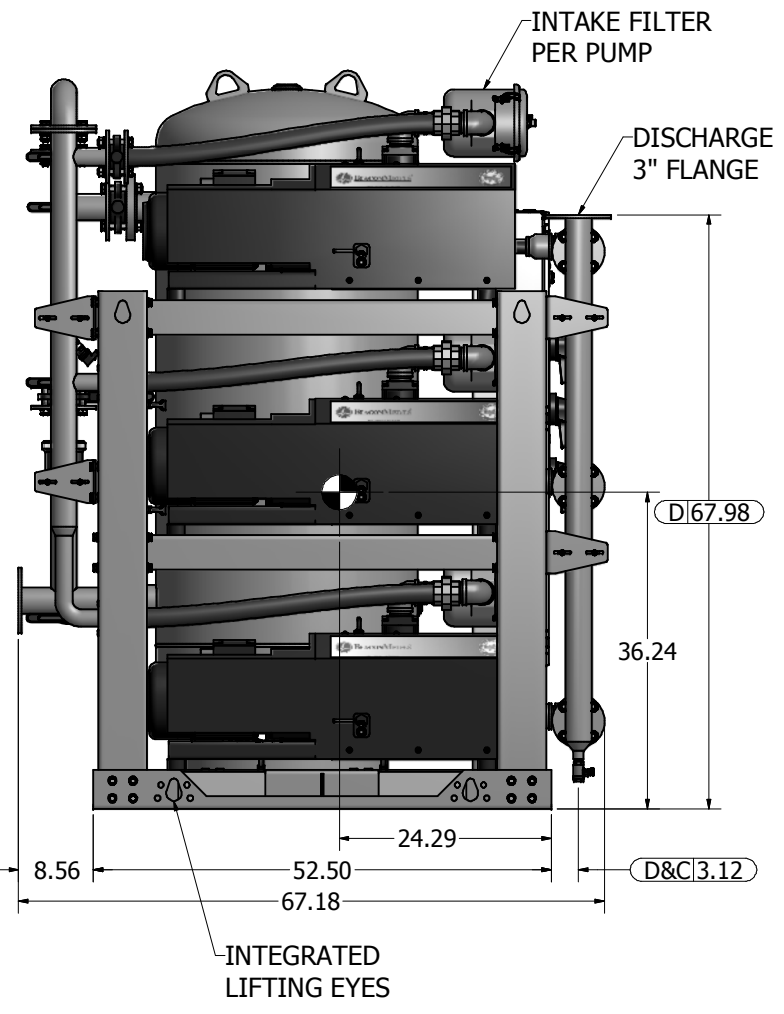
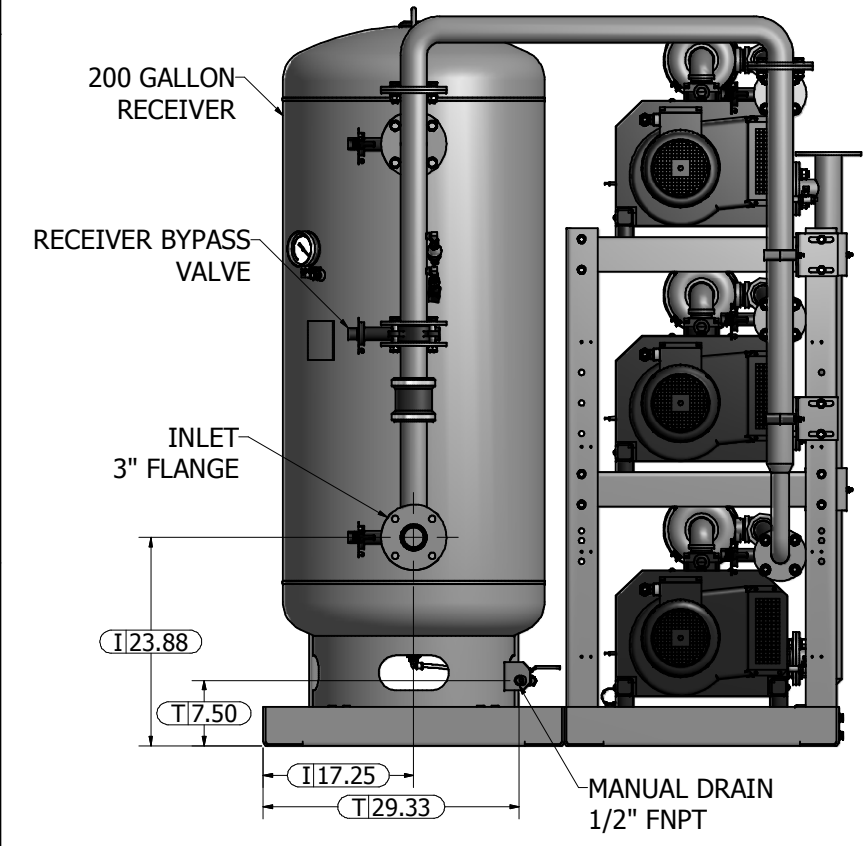
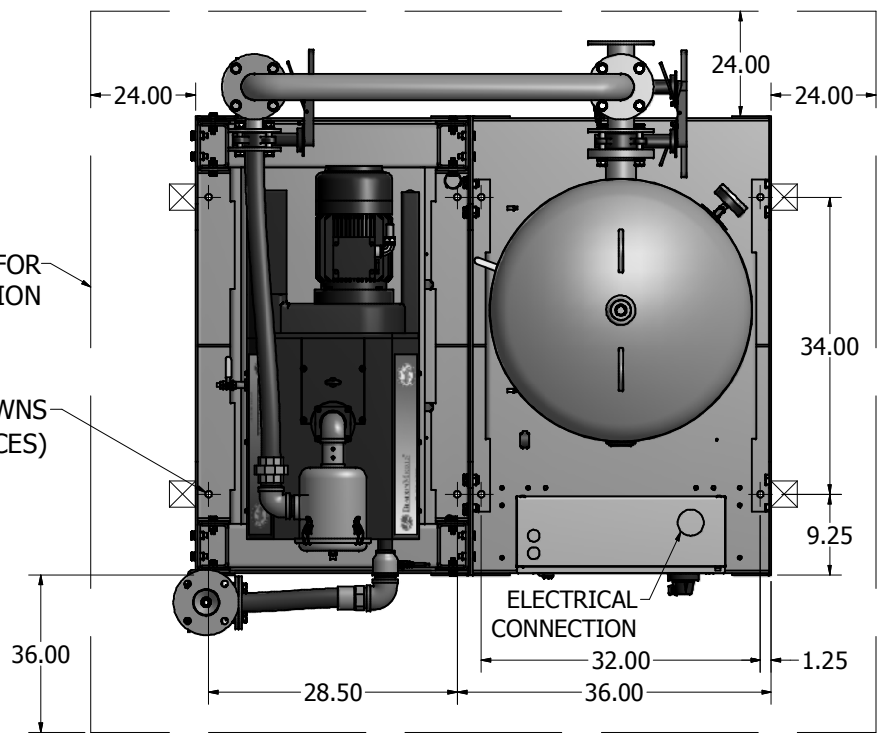

Revised:	Date:	Drawn: MDB	Date: 1/21/2010
		This drawing and the information contained therein remain the property of BeaconMedes and may not be used for other than the purpose for which it is loaned without the expressed written permission from BeaconMedes Engineering.	
Description: GENERAL ASSEMBLY 8.7HP TX CLAW VAC SPC 200G RECEIVER STANDARD & O2 ASSURED		Part Number: 4107 8513 74 DN: USN100038 Rev: 00 Sheet 1 of 1 DO NOT SCALE THIS DOCUMENT	