

Notes:

- DISCHARGE MUFFLERS WILL BE SHIPPED LOOSE.
- DUPLEX MODULE WITH CONTROL BOX WEIGHT: 2,287 LBS  
SIMPLEX MODULE WEIGHT: 1,140 LBS  
240G TANK WEIGHT: 733 LBS
- ☒ INDICATES LIFTING POINT.
- DENOTES CENTER OF GRAVITY.

SYSTEM CONNECTIONS	
ID	DESCRIPTION
I	INLET LOCATION
D	DISCHARGE LOCATION
C	CONDENSATE DRAIN LOCATION
T	TANK DRAIN LOCATION

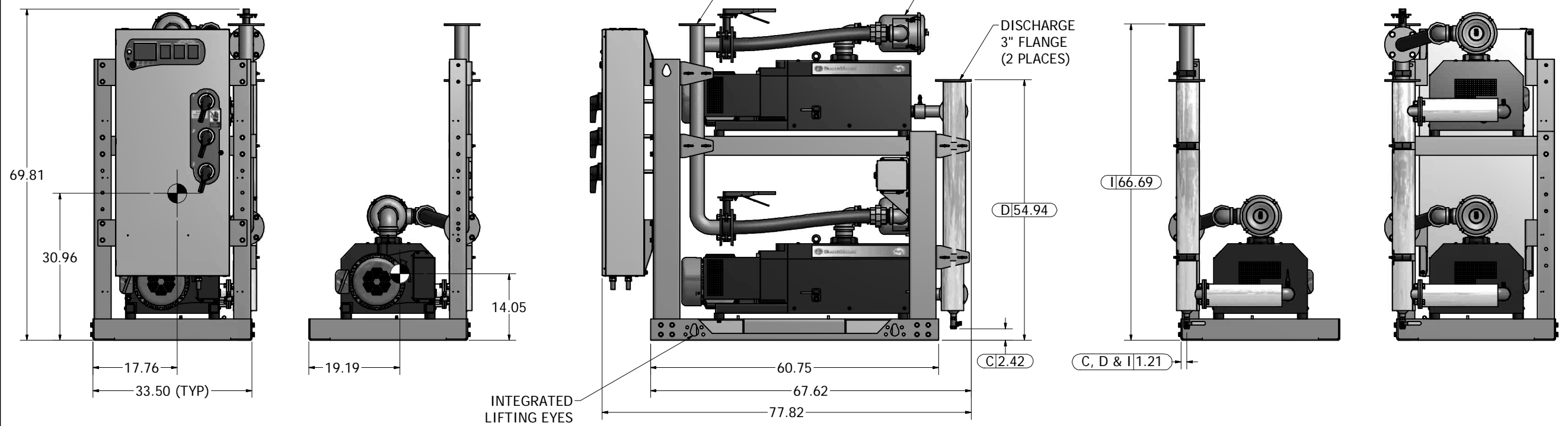
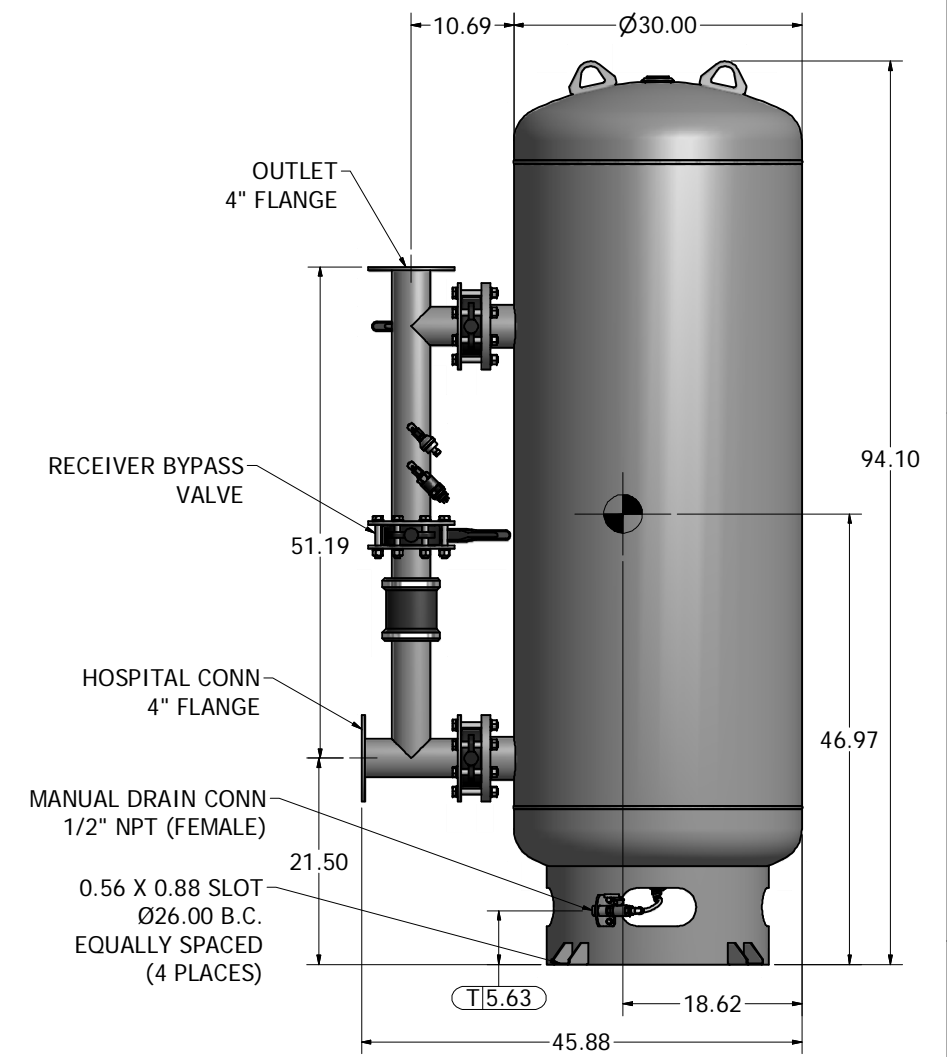
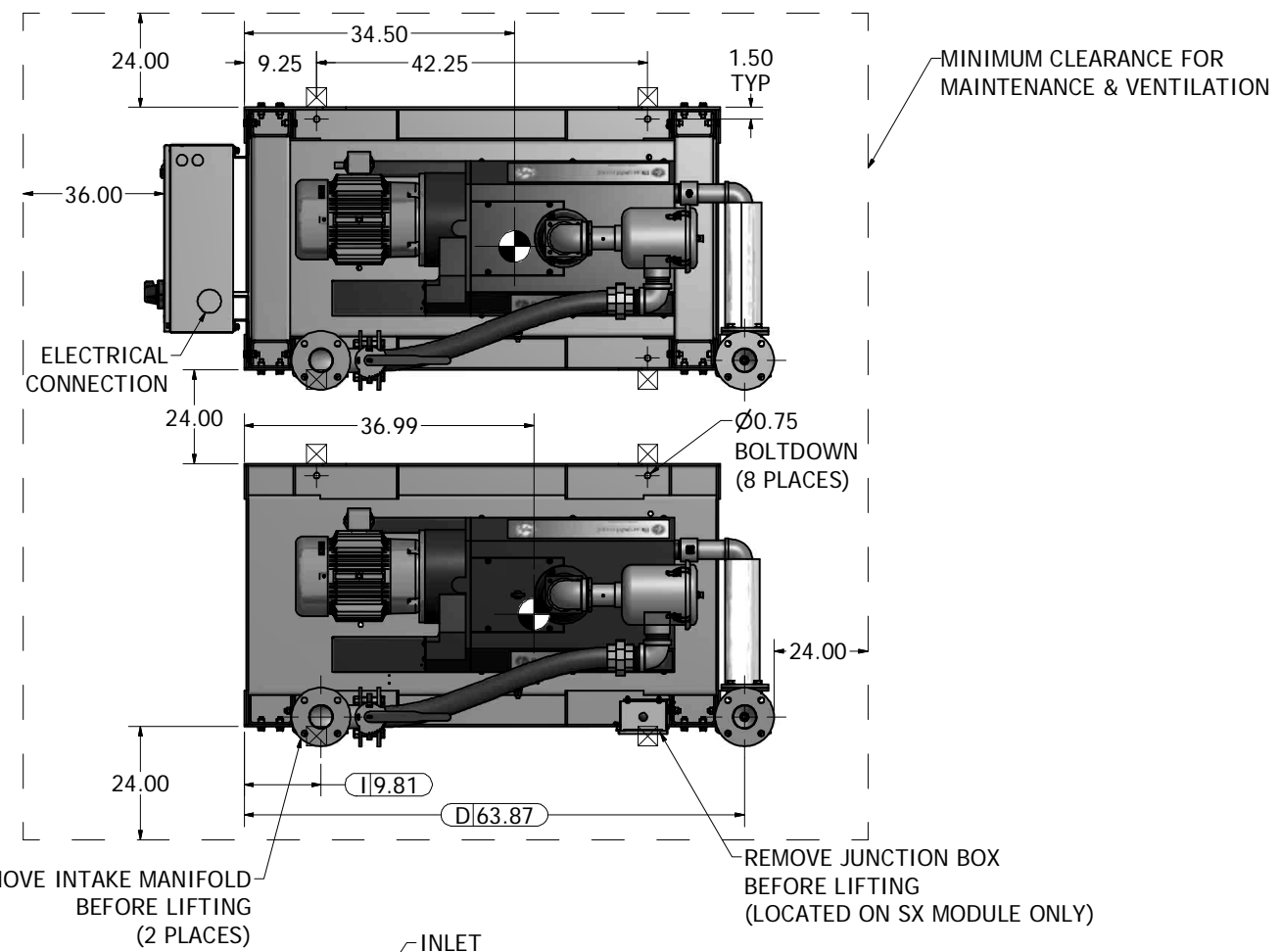

Revised:	Date:	Drawn:	Date:
		MDB	4/13/2012
		This drawing and the information contained therein remain the property of BeaconMedes and may not be used for other than the purpose for which it is loaned without the expressed written permission from BeaconMedes Engineering.	
Description: GENERAL ASSEMBLY 10HP TX CLAW VAC MOD 240G RECEIVER STANDARD AND O2 ASSURED		Part Number: 4107 8539 11 DN: HOP120412 Rev: 00 Sheet 1 of 1 DO NOT SCALE THIS DOCUMENT	