

This drawing and the information contained thereon remain the property of BeaconMedics and may not be used for other than the purpose for which it is loaned without the expressed written permission from BeaconMedics Engineering.

- Notes:
- DISCHARGE MUFFLER WILL BE SHIPPED LOOSE.
 - DX MODULE WEIGHT: 1,788 LBS
240G TANK WEIGHT: 693 LBS
 - ⊠ INDICATES LIFTING POINT.
 - DENOTES CENTER OF GRAVITY.

ID	DESCRIPTION
I	INLET LOCATION
D	DISCHARGE LOCATION
C	CONDENSATE DRAIN LOCATION
T	TANK DRAIN

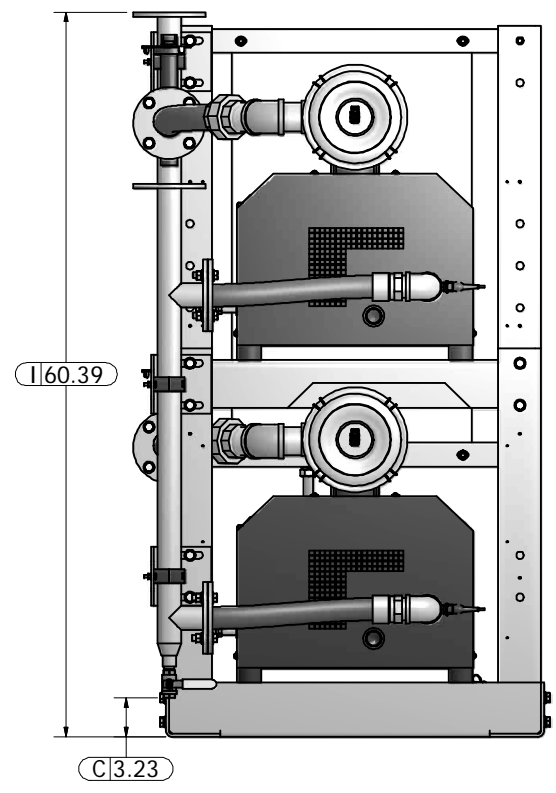
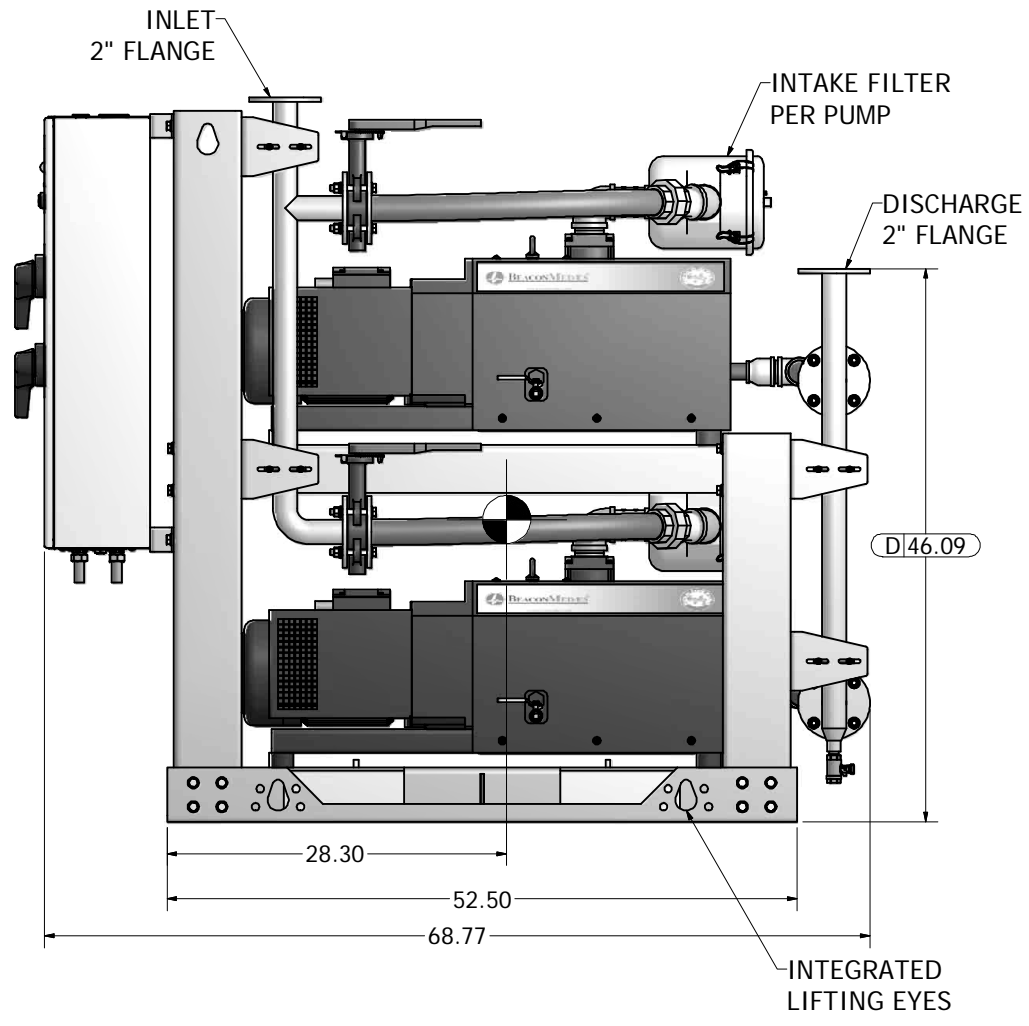
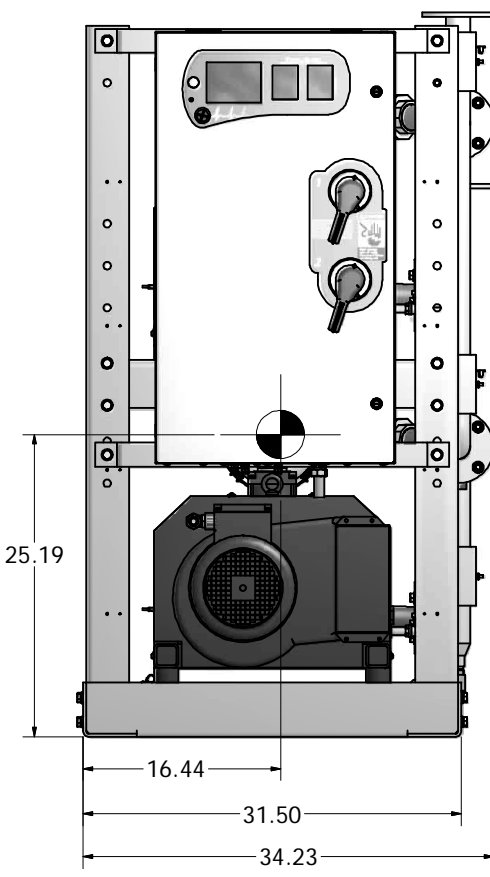
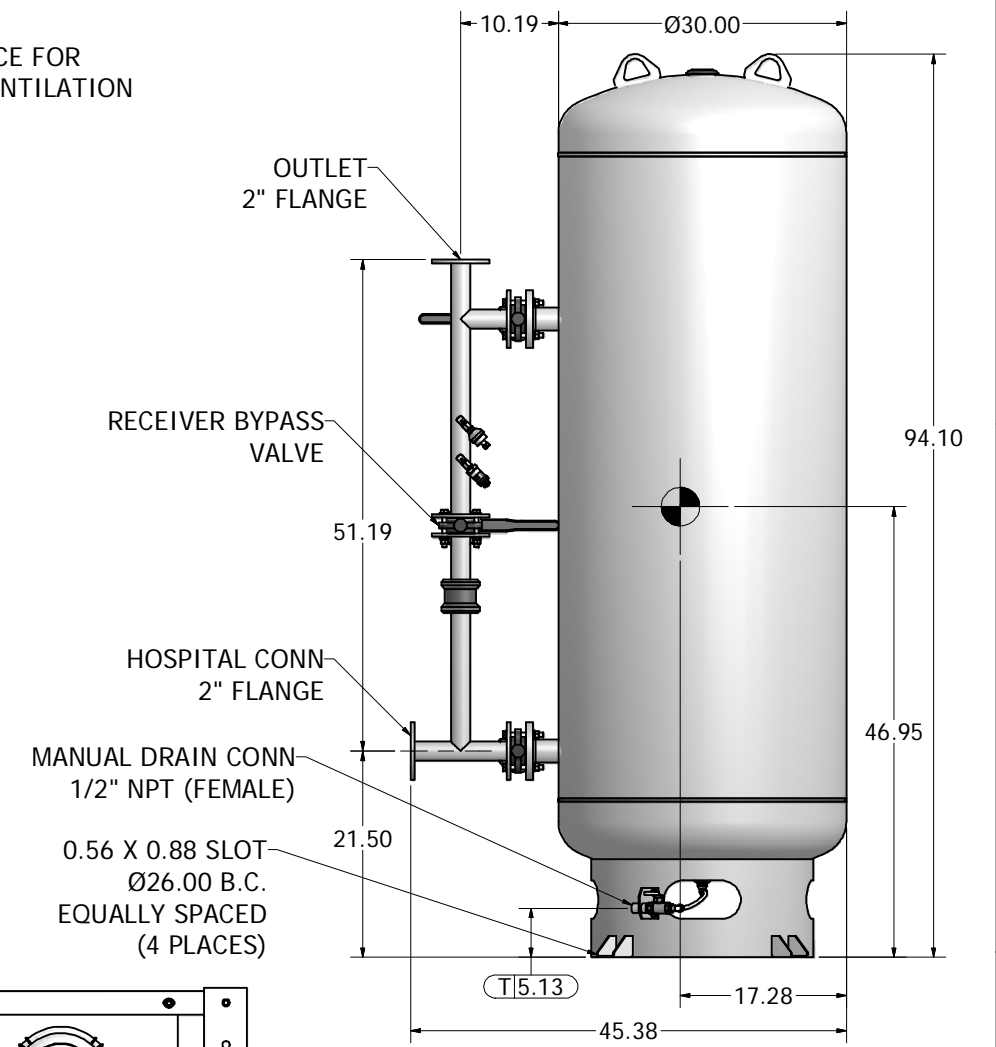
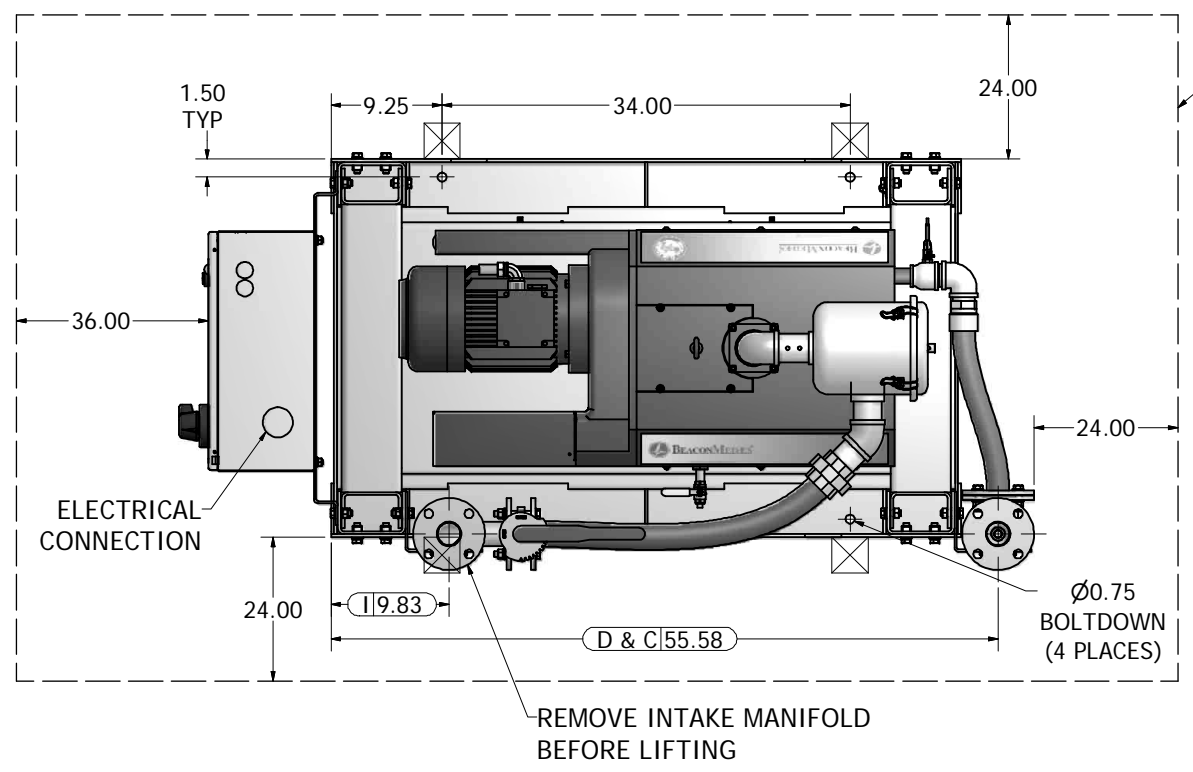

INSPECTION CHECKLIST UNLESS OTHERWISE SPECIFIED:	Revised: _____ Date: _____ Drawn: JDY Date: 1/11/2010	UNLESS OTHERWISE SPECIFIED ALL DIMENSIONS ARE IN INCHES AND TOLERANCES ARE: XX ± .02 XXX ± .005 ANGLES ± .5°	Scale: 1/8
ALL ITEMS MARKED BY ONE OF THE ABOVE SYMBOLS ARE TO BE INSPECTED EQUIPMENT TO BE USED DURING RECEIVING INSPECTION SHALL BE PER QUALITY SYSTEM PROCEDURES	BEACONMEDICS	Description: GENERAL ASSEMBLY 6.4HP DX CLAW VAC MOD 240G RECEIVER STANDARD AND O2 ASSURED	Part Number: 4107 8513 09 Rev: 00 USN100047
	Sheet 1 of 1	DO NOT SCALE THIS DOCUMENT	