

Notes:

1. DISCHARGE MUFFLERS WILL BE SHIPPED LOOSE.
2. SYSTEM WEIGHT: 4,461 LBS. (INCLUDES FUTURE EXPANSION PUMP).
3. ☒ INDICATES LIFTING POINT.
4. ● DENOTES CENTER OF GRAVITY (INCLUDES FUTURE EXPANSION PUMP).

SYSTEM CONNECTIONS	
ID	DESCRIPTION
I	INLET LOCATION
D	DISCHARGE LOCATION
C	CONDENSATE DRAIN LOCATION
T	TANK DRAIN LOCATION

MINIMUM CLEARANCE FOR MAINTENANCE & VENTILATION

Ø0.75 BOLTDOWNS (12 PLACES)

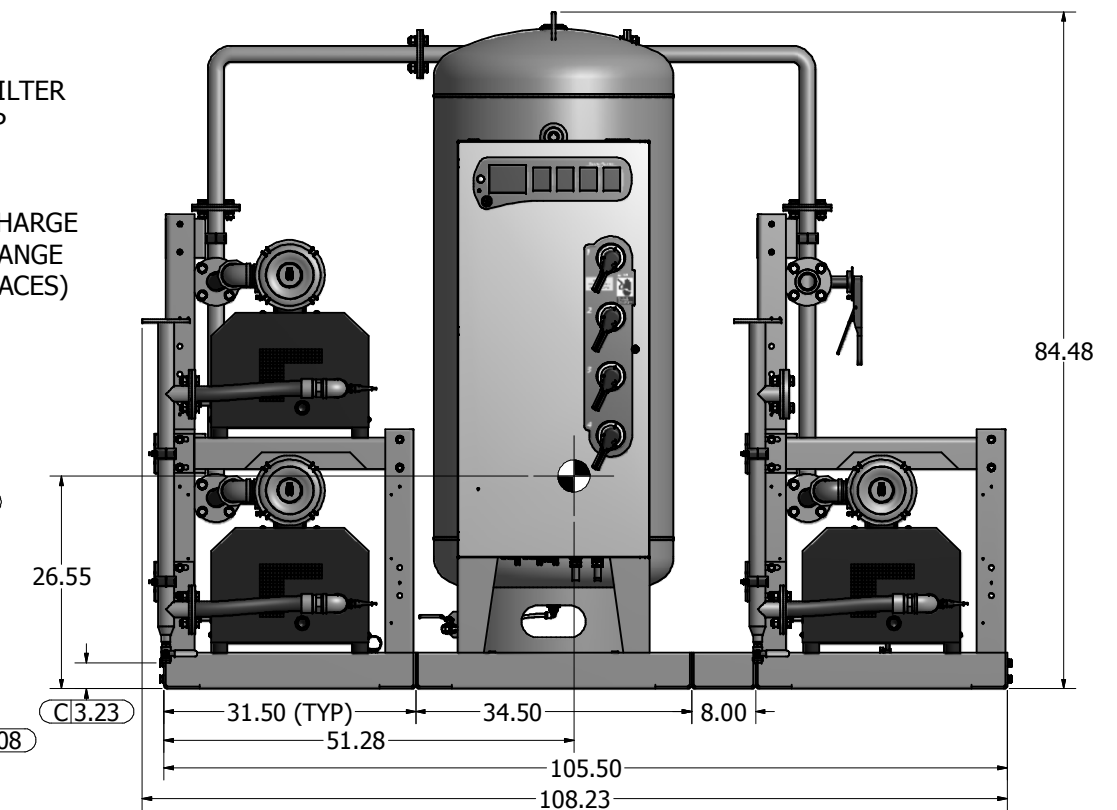
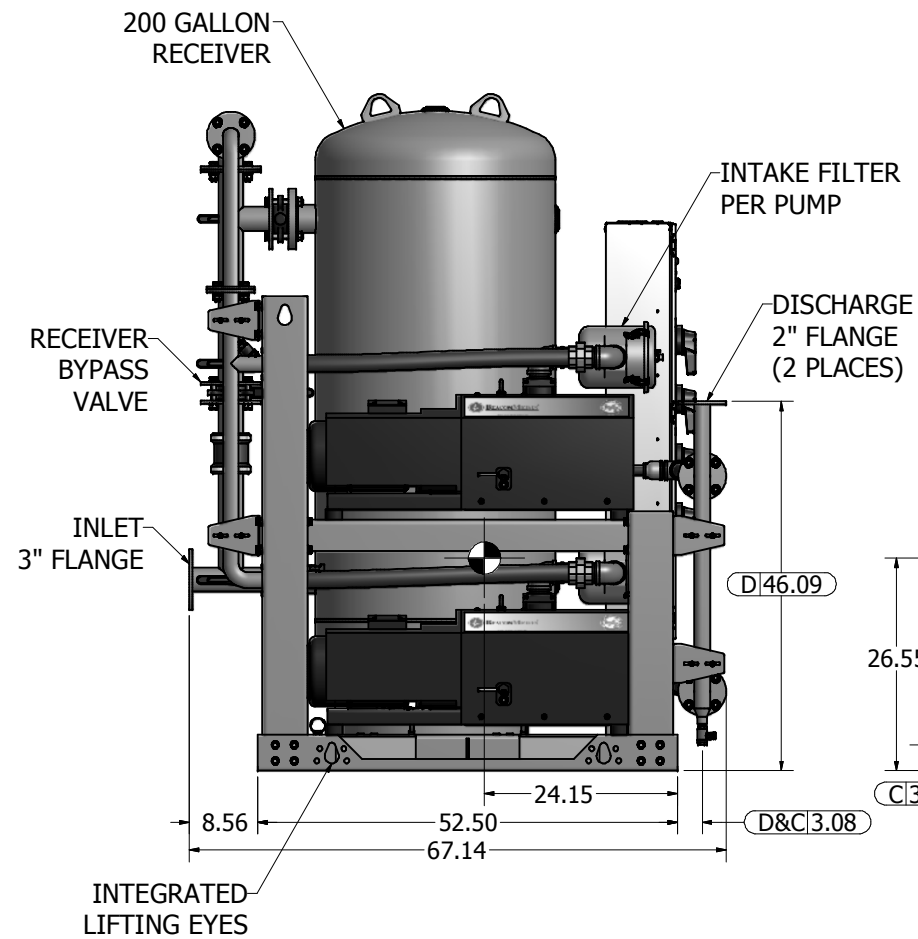
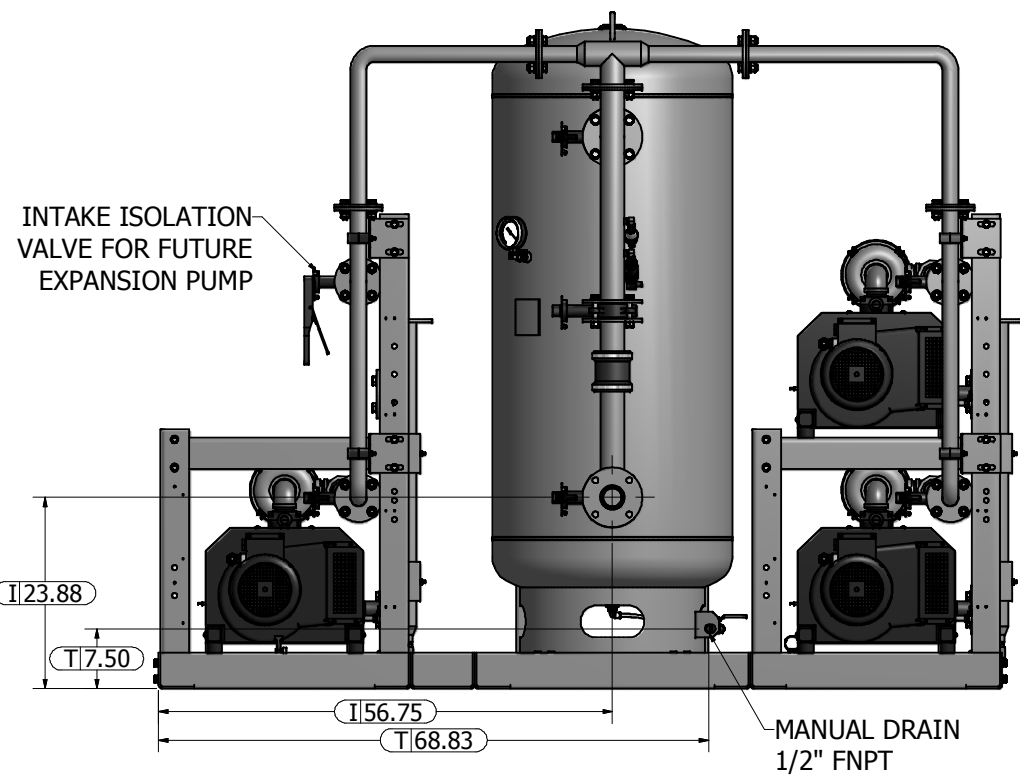
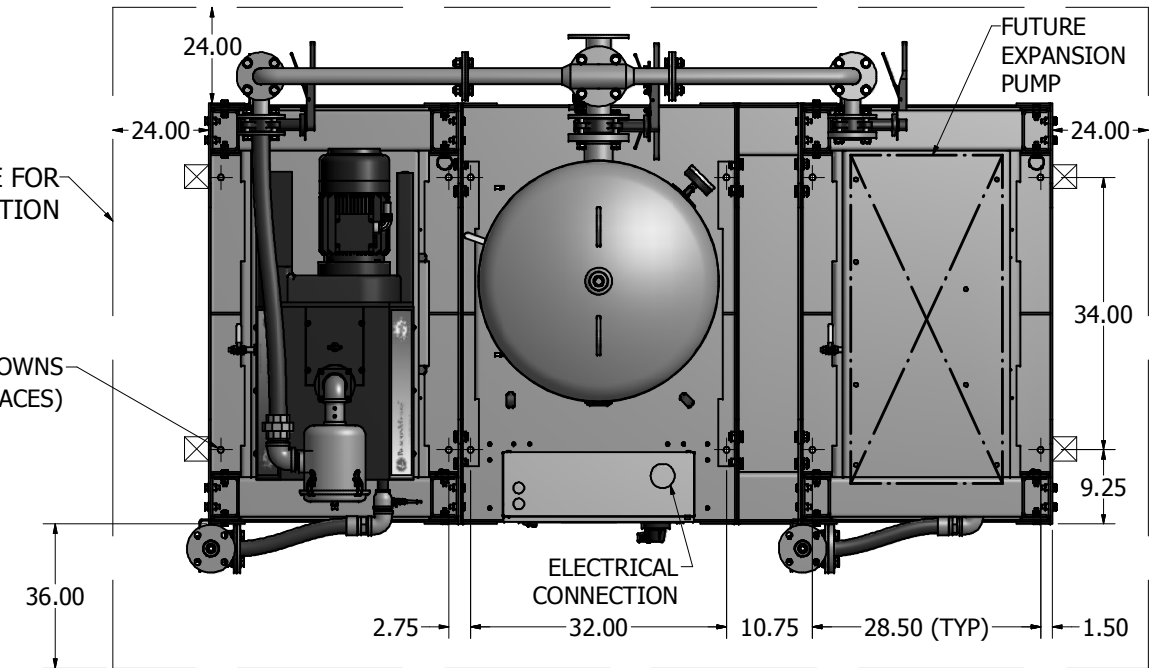

Revised:	Date:	Drawn: MDB	Date: 3/12/2010
		This drawing and the information contained therein remain the property of BeaconMedes and may not be used for other than the purpose for which it is loaned without the expressed written permission from BeaconMedes Engineering.	
Description: GENERAL ASSEMBLY 7.5HP TX-EXP-QX CLAW VAC SPC 200G RECEIVER STANDARD & O2 ASSURED		Part Number: 4107 8515 31 DN: USN100126 Rev: 00 Sheet 1 of 1 DO NOT SCALE THIS DOCUMENT	